

Data Sheet



Article number: 209512M1046209ST

Description: E+G Pulling latches for clamps GN 852
GN 951.2-M10-46-209-ST

Measures

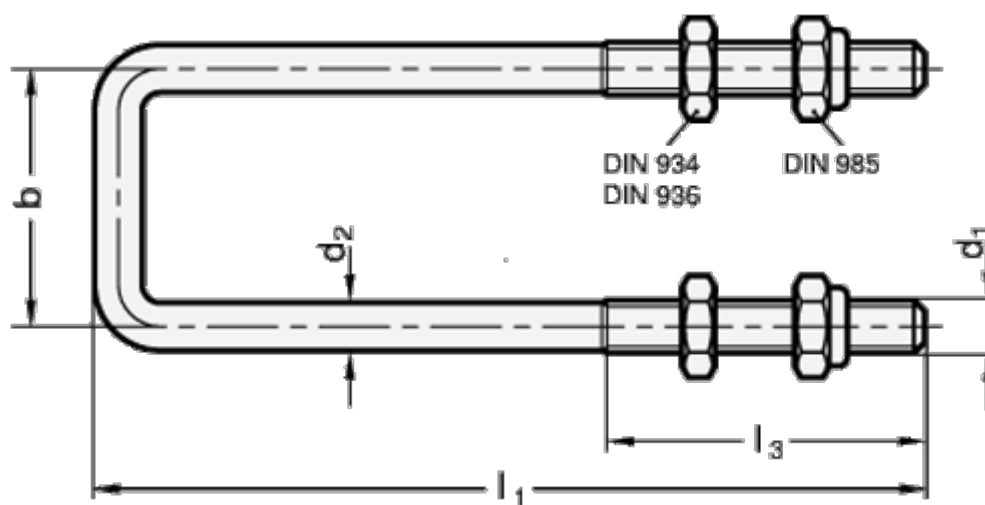

b = 46
d1 = M10
d2 = 9.0
l1 = 209
l3 = 45.0